

**DFN8 1.7×1.3**

**Land Pattern (102-1713-08)**

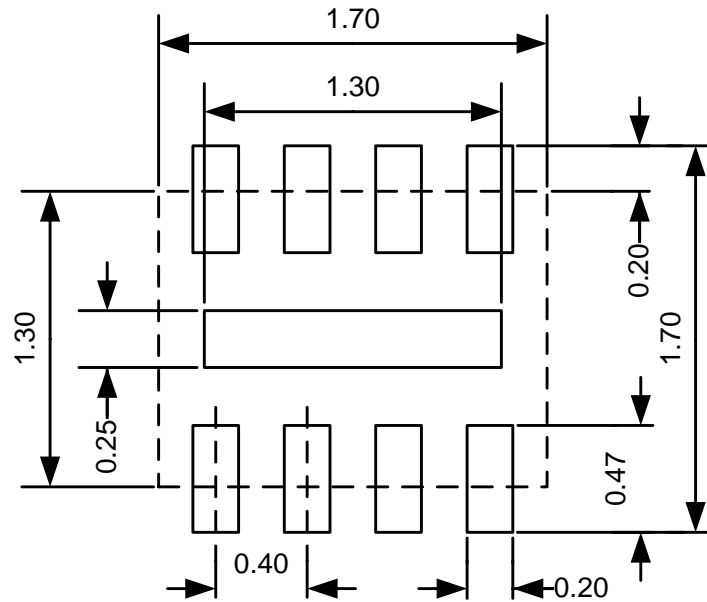

**NOTES:**

1. Compound dimension: 1.70×1.30.
2. Unit: mm.
3. General tolerance  $\pm 0.05$ mm unless otherwise specified.
4. The layout is just for reference.